



# **Social Security**

**National Social Security Office (RSZ/ONSS/LSS)**

All are free to circulate this document with reference to the URL source

## **Service Specification:**

### **Integration and use of the service**

## **EBoxMessage**

**Version 1.3**

To the attention of: "IT expert" aiming to integrate this Service

# Table of Contents

1	Goal of the service .....	5
1.1	Description of the service.....	5
1.1.1	e-Box, from the point of view of institutions – applications.....	5
1.1.2	e-Box for Enterprises, Professionals, Citizens .....	5
1.2	Service consumers.....	7
2	Document management.....	8
2.1	Document history .....	8
2.2	Validation .....	8
2.3	Document references.....	8
2.4	Goal of the document.....	9
3	Service history.....	9
4	Global overview of the Service Group.....	9
5	Prerequisites .....	10
5.1	Business prerequisites .....	10
5.2	Technical prerequisites .....	10
5.2.1	Security .....	11
6	Test, release and exploitation procedures .....	11
7	Description of the service operations .....	12
7.1	WSDL.....	12
7.1.1	Operation publishEboxMessage.....	12
7.1.2	Operation hasAnEbox.....	12
7.1.3	Other operations .....	12
7.2	Operation: publishEboxMessage .....	13
7.2.1	Request message.....	13
7.2.2	Reply message .....	17
7.3	Operation: hasAnEbox.....	18
8	<i>Description of the common types</i> .....	19
8.1	Simple types.....	19
8.1.1	simpleType CBE .....	19
8.1.2	simpleType DigestMethod .....	19
8.1.3	simpleType DigestValue .....	19
8.1.4	simpleType Email .....	19
8.1.5	simpleType FileName .....	20
8.1.6	simpleType FreeText.....	20
8.1.7	simpleType INSS .....	20
8.1.8	simpleType LeftCell .....	20
8.1.9	simpleType MessageType.....	21
8.1.10	simpleType MIME .....	21
8.1.11	simpleType Name.....	21
8.1.12	simpleType NIHII .....	22
8.1.13	simpleType QualityCode.....	22
8.1.14	simpleType RightCell.....	22
8.1.15	simpleType Sequence .....	22
8.1.16	simpleType ShortString .....	23
8.1.17	simpleType ShortTitle .....	23
8.1.18	simpleType Ticket.....	23
8.1.19	simpleType Title.....	23

8.2	complexType: <i>MessageID</i> .....	24
8.3	complexType: <i>RecipientID</i> .....	25
8.4	complexType: <i>Person</i> .....	26
8.5	complexType: <i>File</i> .....	26
8.6	complexType: <i>Digest</i> .....	28
8.7	complexType: <i>FreeInformation</i> .....	28
8.8	complexType Table .....	29
8.9	complexType Row.....	30
8.10	complexType: <i>Meta</i> .....	30
8.11	complexType EntityID .....	32
9	Common error codes.....	34
10	Annex.....	35
10.1	WS EBoxMessage EndPoint URI:.....	35
10.2	Common Quality Codes: .....	35
10.3	Using the X.509 certificate .....	36
10.3.1	Dedicated certificate by sending application .....	36
10.3.2	Single certificate shared by several sending applications .....	37
11	Summary: How to publish for the first time to e-Box? .....	38
12	Contact points.....	38

## Table of Figures

Figure 1	- WS EBoxMessage: overview .....	5
Figure 2	- e-Box Enterprise (preview of the web application) .....	6
Figure 3	- eBox Citizen (preview of the web application) .....	7
Figure 4	- X.509 certificate: parameters .....	10
Figure 5	- Operation publishEboxMessage: overview.....	12
Figure 10	- "Title" of a message (eBox Citizen) .....	27
Figure 12	- "DownloadFileName" (eBox Citizen) [browser Mozilla Firefox] .....	27
Figure 14	- "FreeInformation»: free text (e-Box Professional) .....	29
Figure 15	- "FreeInformation": table (e-Box Professional) .....	30
Figure 16	- "Metadata" displayed on the "message details" page (e-Box Enterprise).....	31
Figure 17	- "Metadata" used as search criteria (e-Box Enterprise).....	32
Figure 18	- Dedicated certificate by application .....	36
Figure 19	- Single certificate shared by several applications .....	37

# 1 Goal of the service

## 1.1 Description of the service

The service EBoxMessage allows the partners in the Social Security sector (the e-Box producers) to publish messages to e-Box. This first paragraph aims to present e-Box in a nutshell.

### 1.1.1 e-Box, from the point of view of institutions – applications

e-Box allows institutions of Belgian Social Security to publish messages of different types for the attention of companies, professionals or citizens. The e-Box system provides a secured Web Service called WS EBoxMessage. This electronic channel is available for the Belgian Social Security Institutions, in order to communicate official documents to companies, professionals or citizens.

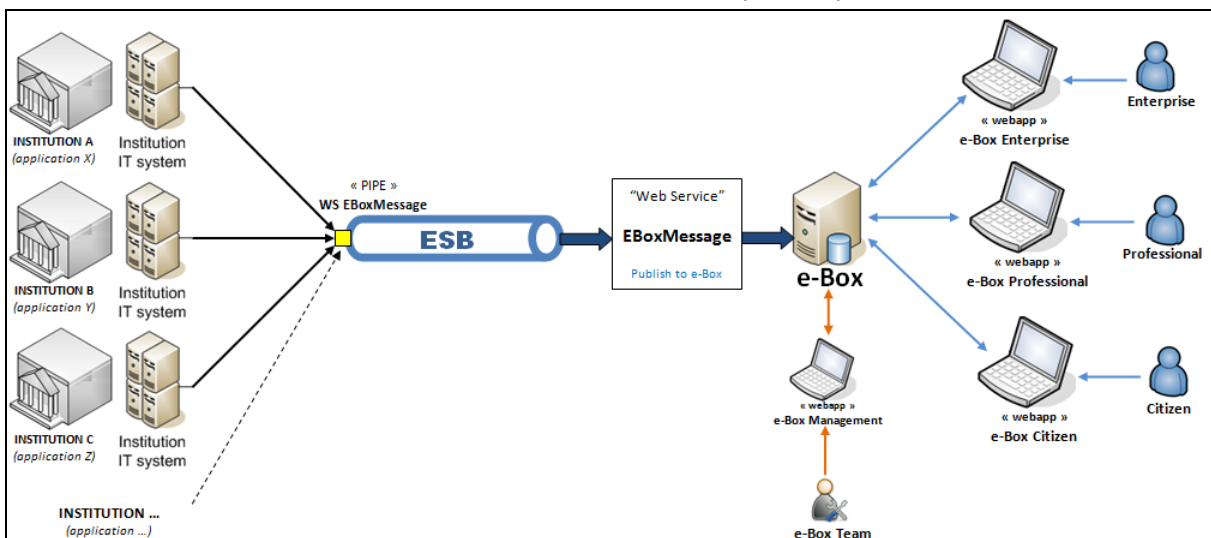

Figure 1 - WS EBoxMessage: overview

### 1.1.2 e-Box for Enterprises, Professionals, Citizens

e-Box is an electronic box, secured and centralized, available as a web application. This protected space is reserved and guaranteed by the Social Security Institutions, for Enterprises, Professionals and Citizens.

- **e-Box Enterprise:** an e-Box is available for each enterprise registered on the Social Security Portal (authentic source = User Management Enterprise, NSSO sector). An e-Box exists for each “quality”<sup>1</sup> defined for the registered enterprises.

*More info:* [https://www.socialsecurity.be/site\\_fr/general/helpcentre/ebox/index.htm](https://www.socialsecurity.be/site_fr/general/helpcentre/ebox/index.htm)

- **e-Box Professional “Institution”:** an e-Box is available for each institution registered in the authentic source “User Management Professional” (CBSS sector). An e-Box exists for each “quality”<sup>2</sup> defined for the registered institutions.

<sup>1</sup> A quality is a business characteristic of an organisation. Example of quality for a company: *Employeur ONSS/ Werkgever RSZ; Employeur ONSS-APL / Werkgever RSZPPO; Secrétariat Social Agréé/ erkende sociale secretariaat; Prestataire de service / dienstverrichter; ...*

<sup>2</sup> A “professional” quality is a business characteristic of an institution. Example of “professional” quality: *Service Administratif de l’institution./ Administratieve dienst...; Service Sécurité de l’institution... / Veiligheidsdienst...; Administration communale / Gemeente bestuur; Action sociale (CPAS)/ Maatschappelijk Welzijn (OCMW)...*

- **e-Box Professional “Personal”**: each civil servant of Belgian Social Security (each user registered below a professional quality in the “User Management Professional”) has access to a personal e-Box. *More info:* [https://www.socialsecurity.be/site\\_fr/civilservant/Applics/epp/index.htm](https://www.socialsecurity.be/site_fr/civilservant/Applics/epp/index.htm)
- **eBox Citizen**: an eBox is available for each citizen in Belgium.  
*More info:* <https://www.mysocialsecurity.be/>

The screenshot shows the e-Box Enterprise web application interface. At the top, there are language options (DE, FR, NL) and a 'Contact' link. The user's name 'ANTOINE JEAN MOULART' and a 'Se déconnecter' link are visible in the top right. The main header features the 'e-Box ENTERPRISE' logo. Below the header, there is a navigation bar with 'Vue par date' and a 'Recherche personnalisée' button. A secondary navigation bar includes 'Tous', 'Documents', 'Notifications', and 'Afficher les Labels'. The main content area is a table with columns for 'Date', 'Institution', 'Emetteur', 'Titre', and actions. The table lists 11 messages, with the first 10 displayed. The messages include notifications from ONSS and ONVA, such as 'Identification auprès de l'ONSS (d mo)', 'Notification Dimona (d mo)', 'EDER501 - Ticket : 340002YV3K008', and 'Donn es de vacances (attestation d finitive)'. At the bottom, there is a pagination bar showing 'R sultats 1   10 (11 r sultats trouv s)' and a 'Suivant' button.

Date	Institution	Emetteur	Titre	A		
24/06/2014	ONSS	WIDE	Identification aupr�s de l'ONSS (d�mo)		T�l�charger	D�tail
24/06/2014	ONSS	DIMONA	Notification Dimona (d�mo) <span>Expire bient�t</span>		T�l�charger	D�tail
03/06/2014	ONSS	EDE	EDER501 - Ticket : 340002YV3K008 <span>Recommand�</span>		T�l�charger	D�tail
16/05/2014	ONSS	MAHIS	Modification d'un mandat		T�l�charger	D�tail
16/05/2014	ONSS	GOTOT GT	Detachement de Dominique Demoniaque (VOLKSKREDIET DE TOREN NV)		T�l�charger	D�tail
16/05/2014	ONSS	GOTOT GT (old)	Detachement de Dominique Demoniaque (VOLKSKREDIET DE TOREN NV)		T�l�charger	D�tail
16/05/2014	ONVA	COVA	Donn�es de vacances (attestation d�finitive)		T�l�charger	D�tail
16/05/2014	ONVA	COVA	Donn�es de vacances		T�l�charger	D�tail
16/05/2014	ONSS	MAHIS	Modification d'un mandat		T�l�charger	D�tail
16/05/2014	ONSS	MAHIS	Cr�ation d'un mandat provisoire		T�l�charger	D�tail

Figure 2 - e-Box Enterprise (preview of the web application)

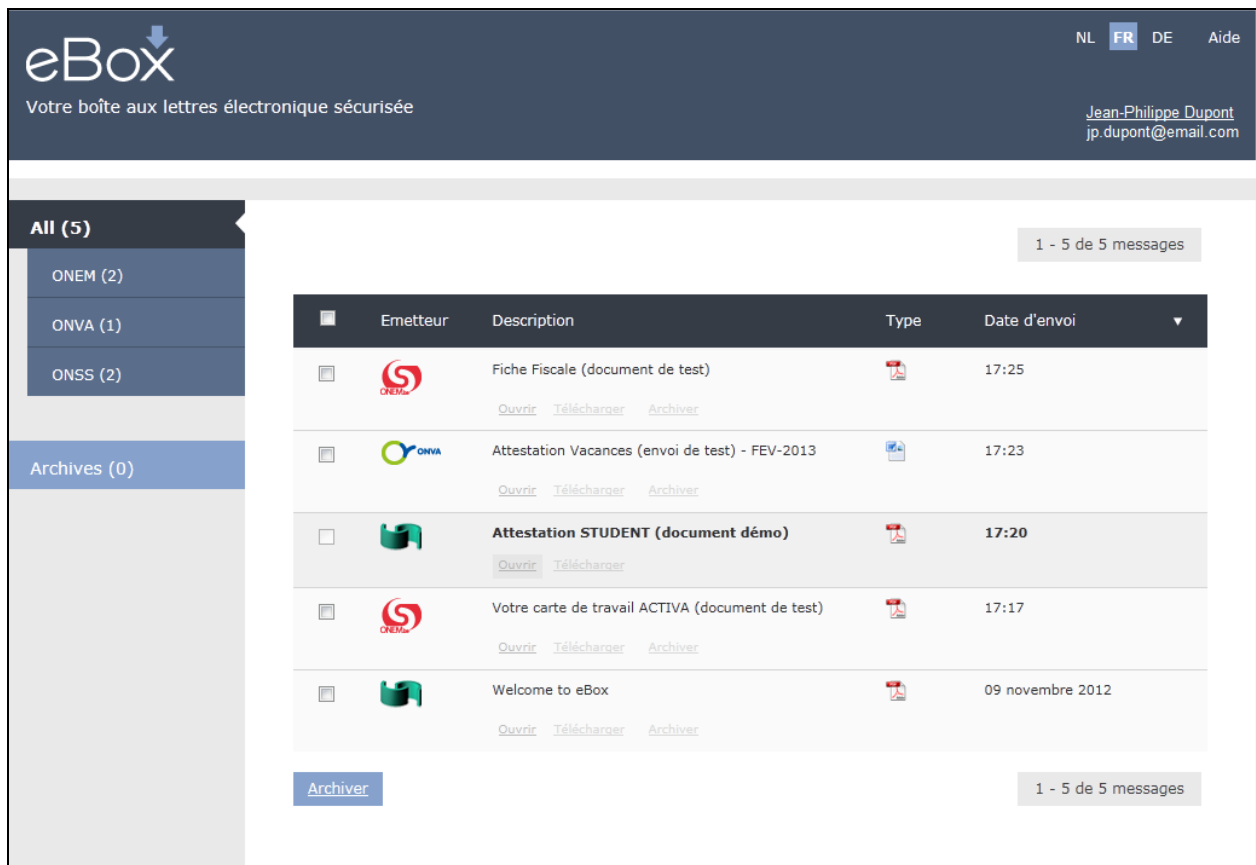

Figure 3 - eBox Citizen (preview of the web application)

## 1.2 Service consumers

The institutions of Belgian Social Security (sender: e-Box producers) that need to publish messages to e-Box of Enterprises, Professionals or Citizens (recipient: e-Box consumers).

## 2 Document management

### 2.1 Document history

Version	Date	Author	Description of changes / remarks
0.1	27/09/2011	A. Moulart	Initial version
0.2	17/10/2011	A. Moulart	Modifications après discussions avec Adrien Clerbaut
0.3	14/12/2011	A. Moulart	Mise-à-jour (dernière version WSDL/XSD).
0.4	13/01/2012	A. Moulart	Ajout des codes d'erreur business
0.5	01/02/2012	A. Moulart	Corrections finales.
0.6	12/03/2012	A. Moulart	Finalisation du document après review d'Adrien Clerbaut.
0.7	26/03/2012	A. Clerbaut	Add security explanation.
0.8	21/09/2012	A. Moulart	Add information about "eBox Citizen" and new operations for broadcast publication
0.9	11/07/2013	A. Moulart	Adaptations suite au review de Denis Vandersteene.
0.10	02/04/2014	A. Moulart	Dernières mises-à-jour
1.0	01/07/2014	A. Moulart	New operation « hasAnEbox » + update e-Box Enterprise screenshots

### 2.2 Validation

Reviewers	Name	Version Reviewed	Remarks

### 2.3 Document references

OASIS WS-Security standards specification :

[https://www.oasis-open.org/committees/tc\\_home.php?wg\\_abbrev=wss](https://www.oasis-open.org/committees/tc_home.php?wg_abbrev=wss)

OASIS Standard X.509 Certificate Token Profile:

<http://docs.oasis-open.org/wss/v1.1/wss-v1.1-spec-os-x509TokenProfile.pdf>



## 2.4 Goal of the document

This document provides functional and technical information on calling the Service EBoxMessage. This information should allow (the IT department of) an organization to integrate and use the service. In this service specification document, we explain the structure and content aspects of the possible service requests and replies. An example illustrates each of those messages. Also, the list of possible errors is included in this document.

Some technical and legal requirements must be satisfied in order to allow the integration of the services in client applications; this document was written in order to provide you with an overview of requirements which have to be met in order to integrate correctly with the Services offered by NSSO (National Social Security Office).

## 3 Service history

This chapter contains the list of changes to the service since the previous publication.

Remark: If only the minor(y) number has changed, the service is backward compatible with the previous version. Existing consumers with no need to use the new functionality do not have to change their implementation.

**Previous version number:** NONE

**Previous release date:** NONE

**List of changes:**

Date	Change
05/07/2012	First version of WS EBoxMessage in Production.
16/08/2012	Support URN as application ID.
26/03/2013	Support of certificates not dedicated to a single application.
<b>2014/q2</b>	+ add "recipient validation" in the WS EBoxMessage ( <i>operation "publish"</i> ); + <i>new operation "HasAnEbox"</i>

## 4 Global overview of the Service Group

Not applicable

## 5 Prerequisites

### 5.1 Business prerequisites

The WS EBoxMessage could only be used by **Social Security Institutions** that are **authorized** to publish to e-Box. The list of these institutions is included in the *Dossier Unique* of the WS EBoxMessage. Institutions that are already known in e-Box belong to this list. If a new institution wants to use the WS, the *Dossier Unique* must be updated.

A SOAP request to the WS EBoxMessage must be signed by means of a *X.509 certificate* (cf. Technical prerequisites, below). The WS EBoxMessage identifies the message sender on the basis of this certificate.

Each e-Box message is coupled to a **message type**.

A message type is associated with some essential pieces of information:

- “Application – institution” couple(s) that is (are) authorized to publish messages of this type.
- Validity period for messages of this type (the message is deleted from e-Box after its validity period has elapsed).
- Metadata linked to this message type (optional or mandatory + their format). Metadata can be used to add structured information about the message (for example: a NSSO number; a quarter date; a request date; etc.). Metadata can be used as search criteria among messages of a same type.
- Additional information about message updates; category...

When an institution wants to publish a new kind of message to e-Box, the message type must be defined with e-Box GA/TB ([eBoxIntegration@smals.be](mailto:eBoxIntegration@smals.be)) by means of an **identification form**.

This form is available on <http://portalinfo.smals.be/>.

Depending on the targeted recipients (Enterprises – Professionals – Citizens), an **agreement is required** coming from the owner institution (NSSO or CBSS). This business validation

### 5.2 Technical prerequisites

To call the WS you must sign your soap request with a Fedict X509 certificate.

This certificate identifies the institution and the application.

X509	Value	Comment
C	BE	-
O	Federal Government	-
OU	<i>Institution Name</i>	Example OU=National Social Security Office
OU	OU=urn:be:fgov:kbo-bce:organization:cbe-number:\${CBE}	Example for institution with CBE 1234567890 this OU must be OU=urn:be:fgov:kbo-bce:organization:cbe-number:1234567890
CN	<i>Application identifier</i>	-

Figure 4 - X.509 certificate: parameters

## 5.2.1 Security

### Transport security

- For transport security one way SSL applies. The SSL connection will provide encryption to the data transported, as well as server authentication of the service provider.

### Message security

- Message security using the OASIS WS-Security standards provides authentication of the service consumer and protects the message integrity end-to-end. See section 2.3 for links to the specifications.
- **Direct authentication (OASIS Standard X.509 Certificate Token Profile):** The consumer includes its X.509 certificate (`wsse:BinarySecurityToken`) and a timestamp (`wsu:Timestamp`) within the `wsse:Security` header. The consumer signs the entire SOAP body, timestamp and BST headers.

# 6 Test, release and exploitation procedures

/

## 7 Description of the service operations

### 7.1 WSDL

WSDL and XSD are available on: <http://portalinfo.smals.be/>

#### 7.1.1 Operation publishEboxMessage

- Publish a document to an e-Box

 Different types of e-Box exist (cf. 1.1). In the request, a “Quality Code” must be given in the “Recipient” tag (cf. 7.2). That will automatically correspond to an e-Box type. See also Annex 10.2 for the list of commons quality codes.

 The recipient’s validation is now checked for this operation at the ESB level. That means that a publish request with an invalid recipient (example: the Enterprise doesn’t exist) will generate a business error with the code ‘90’ (‘Invalid Recipient’). See also Chapter 9 for the complete list of the potential error codes.

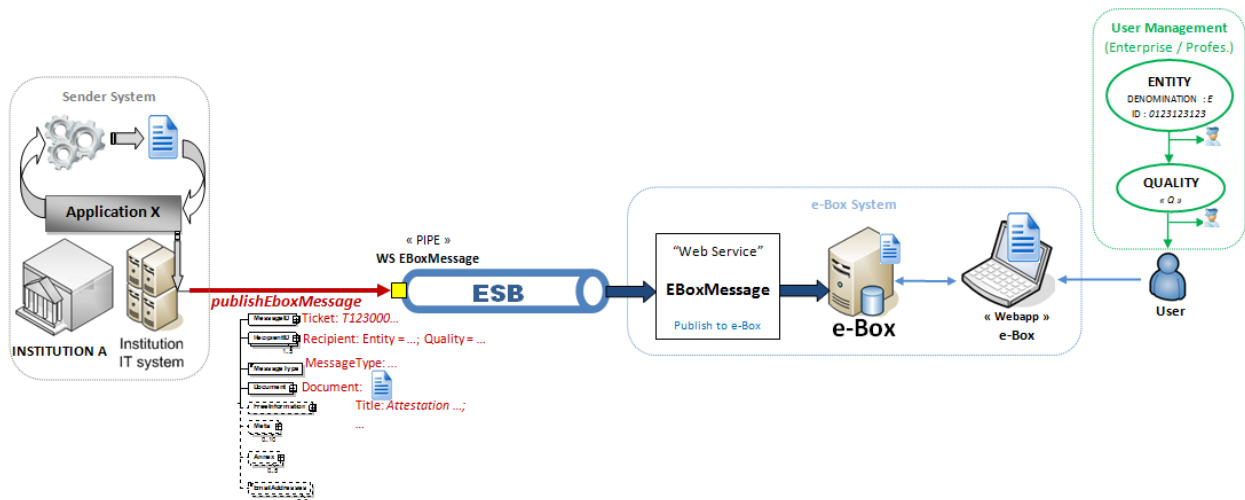

Figure 5 - Operation publishEboxMessage: overview

#### 7.1.2 Operation hasAnEbox

- Check if an e-Box exists (and if the e-Box is already used, get the last connection date, in order to know if this e-Box is really used)

**Request:** identification of a (list of) e-Box, for a same quality code. For each e-Box: entity value (ex: CompanyID or INSS).

**Response:** for each e-Box: available(Y/N)? If e-Box already used, date of last connection.

#### 7.1.3 Other operations

4 other operations (*getEboxInfo*, *storeEboxMessage*, *linkEboxMessage*, *commitLinkEboxMessage*) appear in the WSDL but are restricted for internal use. These operations are not documented in this Service Specification Guide.

## 7.2 Operation: publishEboxMessage

The publishEboxMessage operation is used to publish a new message to e-Box. This message contains of course the document that will be published in the recipient's e-Box, but it is coupled with different pieces of information: *message's ticket (id)*, *type of message*, *document's title*, *document's "download file name"*, *optional free information*, *metadata or annex...*

This section presents the structure of request and reply messages.



Screenshots of the e-Box web application help the reader understand how input parameters are used and handled to integrate/show a document in the e-Box. The e-Box's interfaces are similar between e-Box Enterprise and e-Box Professional. eBox Citizen's interface looks different, and therefore, some elements that could be provided in a request are not supported with eBox Citizen.



Two request messages (a minimal version and a more detailed one) are explained into details.

Simple and complex types of the XSD are explained in 8. *Description of the common types*.

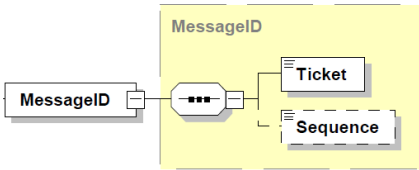
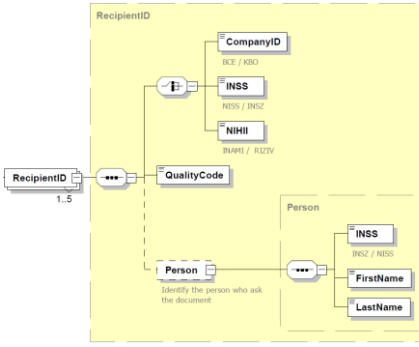
### 7.2.1 Request message

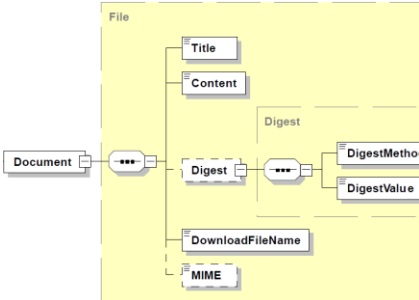
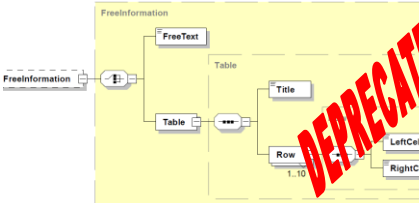
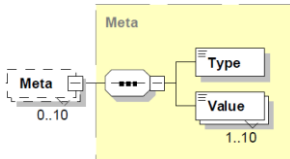
<p>diagram</p>	
<p>source</p>	<pre> &lt;xs:complexType name="PublishEboxMessageRequest"&gt;   &lt;xs:annotation&gt;     &lt;xs:documentation&gt;Complex Type defining an PublishEboxMessageRequest&lt;/xs:documentation&gt;   &lt;/xs:annotation&gt;   &lt;xs:sequence&gt;     &lt;xs:element name="MessageID" type="MessageID"/&gt;     &lt;xs:element name="RecipientID" type="RecipientID" maxOccurs="5"/&gt;     &lt;xs:element name="MessageType" type="MessageType"/&gt;     &lt;xs:element name="Document" type="File"/&gt;     &lt;xs:element name="FreeInformation" type="FreeInformation" minOccurs="0"/&gt;     &lt;xs:element name="Meta" type="Meta" minOccurs="0" maxOccurs="10"/&gt;     &lt;xs:element name="Annex" type="File" minOccurs="0" maxOccurs="5"/&gt;     &lt;xs:element name="EmailAddresses" type="Email" minOccurs="0" maxOccurs="5"/&gt;   &lt;/xs:sequence&gt; &lt;/xs:complexType&gt; </pre>

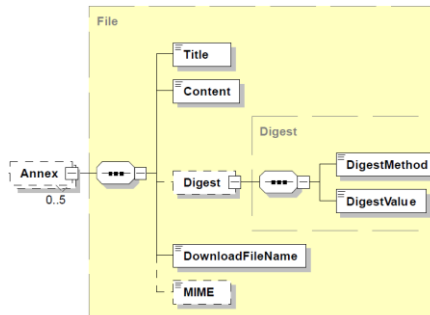
<b>PublishEboxMessageRequest</b>	<b>Explanations:</b>
	<p><b>MessageID</b> (cf. <a href="#">complexType: MessageID</a>)</p> <p><b>Ticket:</b> functional identifier of the message. Most often, the ticket has a business meaning for the application that sends the message (for example, the reference of a declaration).</p> <p><b>Sequence [optional]:</b> The sequence number is used to publish different versions of a message having the same ticket number. For example, it is possible to have 3 messages with ticket “12345678”, and sequence “1”, “2” and “3” for each version of the message.</p> <p>Sending a message with an already used ticket/sequence combo will replace the existing message.</p>
	<p><b>RecipientID</b> [1..5] (cf. <a href="#">complexType: RecipientID</a>)</p> <p>A RecipientID defines an “Entity/Quality couple” that identifies the e-Box where the message will be published.</p> <p><b>CompanyID or INSS or NIHI:</b> entity id of the recipient, according to the entity type, respectively, an organization (enterprise or institution), an individual (for example a Citizen) or a provider of health care.</p> <p><b>QualityCode:</b> quality code linked to the given entity. The quality code depends of the “e-Box type”.</p> <p><b>Person [optional; only for “e-Box Enterprise” and “e-Box Professional Institution”]:</b> a person who is a target recipient among the different users of the specified e-Box.</p>
	<p><b>MessageType:</b> identifies the type of the message. A message type is defined with <a href="mailto:eBoxIntegration@smals.be">eBoxIntegration@smals.be</a> when an institution wants to publish a new sort of message to e-Box (by means of an identification form). Each message type is associated to an institution, a sender application, a validity period, some security checks, and possible metadata.</p>
	<p><b>Document</b> (cf. <a href="#">complexType: File</a>)</p> <p>Document that will be publish in the specified e-Box. A document has a Title, a Content and a DownloadFileName (with its file extension).</p> <p>A Digest and the MIME-type could be provided.</p>
 <p style="color: red; font-weight: bold; font-size: 2em; transform: rotate(-45deg); position: absolute; top: 50%; left: 50%; opacity: 0.5;">DEPRECATED</p>	<p><b>FreeInformation:</b> free information in the form of a free text or a table. On the “details page” of the message, the table or the free text is displayed on the top right side of the page (cf. print-screens just below).</p> <p><b>DEPRECATED</b> (only exploited in e-Box Professional)</p>
	<p><b>Meta</b> (cf. <a href="#">complexType: Meta</a>)</p> <p>Metadata are used to add more structured information about a message. Metadata are defined for a “message type”, and can be optional or mandatory. In e-Box, metadata can be used as search criteria.</p> <p><b>NOT USED IN EBOX CITIZEN</b></p>

	<p><b>Annex:</b> it is possible to add 1 to 5 annexes in a message. An annex has the same type that a document.</p> <p>In e-Box, a title is followed by a <i>paper clip</i> symbol in order to indicate that some annexes are joined in this message.</p> <p>The “details page” of a message allows a user to consult or download the annexes (cf. print-screen just below).</p> <p><b>NOT USED IN EBOX CITIZEN</b></p>
	<p><b>EmailAddresses:</b> Mail addresses that the sender could add (optional) – max. 5 mail addresses.</p> <p>e-Box sends a notification mail to these addresses in order to indicate that there is a new incoming message in the e-Box of the recipient (not used for eBox Citizen).</p> <p><b>NOT USED IN EBOX CITIZEN</b></p>

#### Example 1:

#### Minimal version of a message:

```
<?xml version="1.0" encoding="UTF-8"?>
<PublishEboxMessageRequest
xsi:schemaLocation="http://socialsecurity.be/eboxmessage/v1 EboxMessage_v1.xsd"
xmlns="http://socialsecurity.be/eboxmessage/v1"
xmlns:types="http://socialsecurity.be/eboxmessage/types/v1"
xmlns:xsi="http://www.w3.org/2001/XMLSchema-instance">
  <types:MessageID>
    <types:Ticket>testWSebox2012</types:Ticket>
  </types:MessageID>
  <types:RecipientID>
    <types:CompanyID>0123456789</types:CompanyID>
    <types:QualityCode>QUAL_EMP_NOSS</types:QualityCode>
  </types:RecipientID>
  <types:MessageType>DIMONA1</types:MessageType>
  <types:Document>
    <types:Title>titre</types:Title>
    <types:Content>cid:534484181045</types:Content>
    <types:DownloadFileName>test.pdf</types:DownloadFileName>
  </types:Document>
</PublishEboxMessageRequest>
```

Example 2:

**Message Request with 2 recipients, 2 metas and 3 annexes.**

```
<v1:PublishEboxMessageRequest>
  <v11:MessageID>
    <v11:Ticket>12345678</v11:Ticket>
    <v11:Sequence>2</v11:Sequence>
  </v11:MessageID>
  <v11:RecipientID>
    <v11:INSS>999999999999</v11:INSS>
    <v11:QualityCode>PROFESSIONAL</v11:QualityCode>
  </v11:RecipientID>
  <v11:RecipientID>
    <v11:CompanyID>1234567890</v11:CompanyID>
    <v11:QualityCode>QUAL_EMP_NOSS</v11:QualityCode>
    <v11:Person>
      <v11:INSS>999999999999</v11:INSS>
      <v11:FirstName>Francois</v11:FirstName>
      <v11:LastName>Full</v11:LastName>
    </v11:Person>
  </v11:RecipientID>
  <v11:RecipientID>
    <v11:CompanyID>1234567890</v11:CompanyID>
    <v11:QualityCode>QUAL_SP_LEG</v11:QualityCode>
  </v11:RecipientID>
  <v11:MessageType>DocWIDE</v11:MessageType>
  <v11:Document>
    <v11:Title>document de test pour ebox</v11:Title>
    <v11:Content>cid:534484181045</v11:Content>
    <v11:Digest>
      <v11:DigestMethod>SHA-256</v11:DigestMethod>
    <v11:DigestValue>YTONFS1mEb7N01hNH6S3KMslS5mm4/rf+cgkiuhloys=</v11:DigestValue>
    </v11:Digest>
    <v11:DownloadFileName>document.pdf</v11:DownloadFileName>
    <v11:MIME>application/pdf</v11:MIME>
  </v11:Document>
  <v11:Meta>
    <v11:Type>BENOSS</v11:Type>
    <v11:Value>0987654321</v11:Value>
    <v11:Value>1234567890</v11:Value>
  </v11:Meta>
  <v11:Meta>
    <v11:Type>RequestDate</v11:Type>
    <v11:Value>2012-03-12</v11:Value>
  </v11:Meta>
  <v11:Annex>
    <v11:Title>title first Annex</v11:Title>
    <v11:Content>cid:534484181045</v11:Content>
    <v11:Digest>
      <v11:DigestMethod>SHA-256</v11:DigestMethod>
    <v11:DigestValue>YTONFS1mEb7N01hNH6S3KMslS5mm4/rf+cgkiuhloys=</v11:DigestValue>
    </v11:Digest>
    <v11:DownloadFileName>ANNEXE01.pdf</v11:DownloadFileName>
    <v11:MIME>application/pdf</v11:MIME>
  </v11:Annex>
  <v11:Annex>
    <v11:Title>title annex 2</v11:Title>
    <v11:Content>cid:524157812819</v11:Content>
```



```

<v11:DownloadFileName>annex2.csv</v11:DownloadFileName>
<v11:MIME>text/csv</v11:MIME>
</v11:Annex>
<v11:Annex>
  <v11:Title>Annex 3 Title</v11:Title>
  <v11:Content>cid:524157812819</v11:Content>
  <v11:DownloadFileName>annex3.csv</v11:DownloadFileName>
  <v11:MIME>text/csv</v11:MIME>
</v11:Annex>
</v1:PublishEboxMessageRequest>

```

## 7.2.2 Reply message

complexType **PublishEboxMessageResponse**

diagram	<p>Response of a PublishEboxMessageRequest</p>
source	<pre> &lt;xs:complexType name="PublishEboxMessageResponse"&gt;   &lt;xs:annotation&gt;     &lt;xs:documentation xml:lang="en"&gt;Response of a PublishEboxMessageRequest&lt;/xs:documentation&gt;   &lt;/xs:annotation&gt;   &lt;xs:sequence&gt;     &lt;xs:element name="ID" type="xs:string"/&gt;   &lt;/xs:sequence&gt; &lt;/xs:complexType&gt; </pre>

### Example:

```

<PublishEboxMessageResponse>
  <ID>035000373APHZ</ID>
</PublishEboxMessageResponse>

```

### Explanation:

This ID is a technical message ID. This message ID can be used to search the message in e-Box, for example in order to check the publication.

This kind of answer means that the message will be treated. If an error occurs at the WS level, an error code is returned (cf. 9. *Common error codes*).

### 7.3 Operation: hasAnEbox

This operation can be used to check if an e-Box exists (and if the e-Box is already used, get the last connection date<sup>3</sup>, in order to know if this e-Box is really used)

**Request:** identification of a (list of) e-Box, for a same quality code. For each e-Box: entity value (ex: CompanyID or INSS).

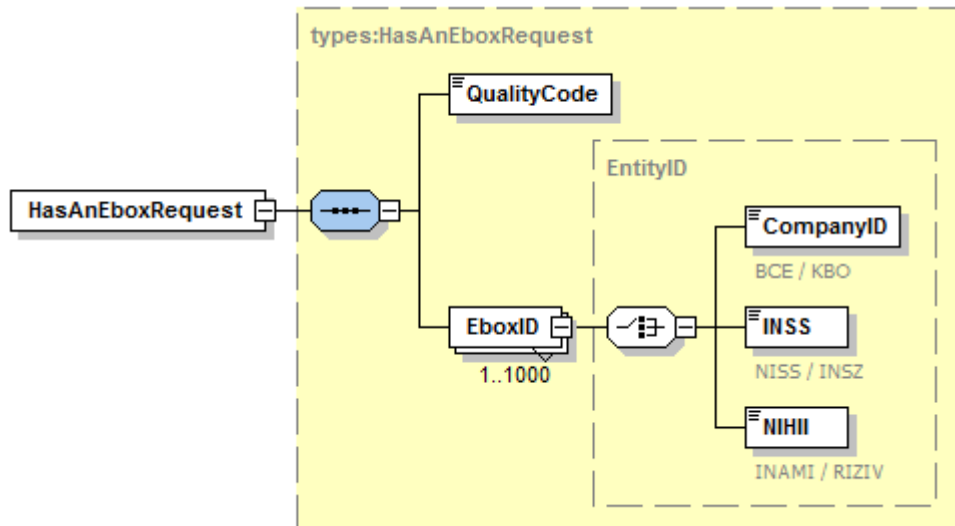

**Response:** for each e-Box: available(Y/N)? If e-Box already used, date of last connection<sup>4</sup>.

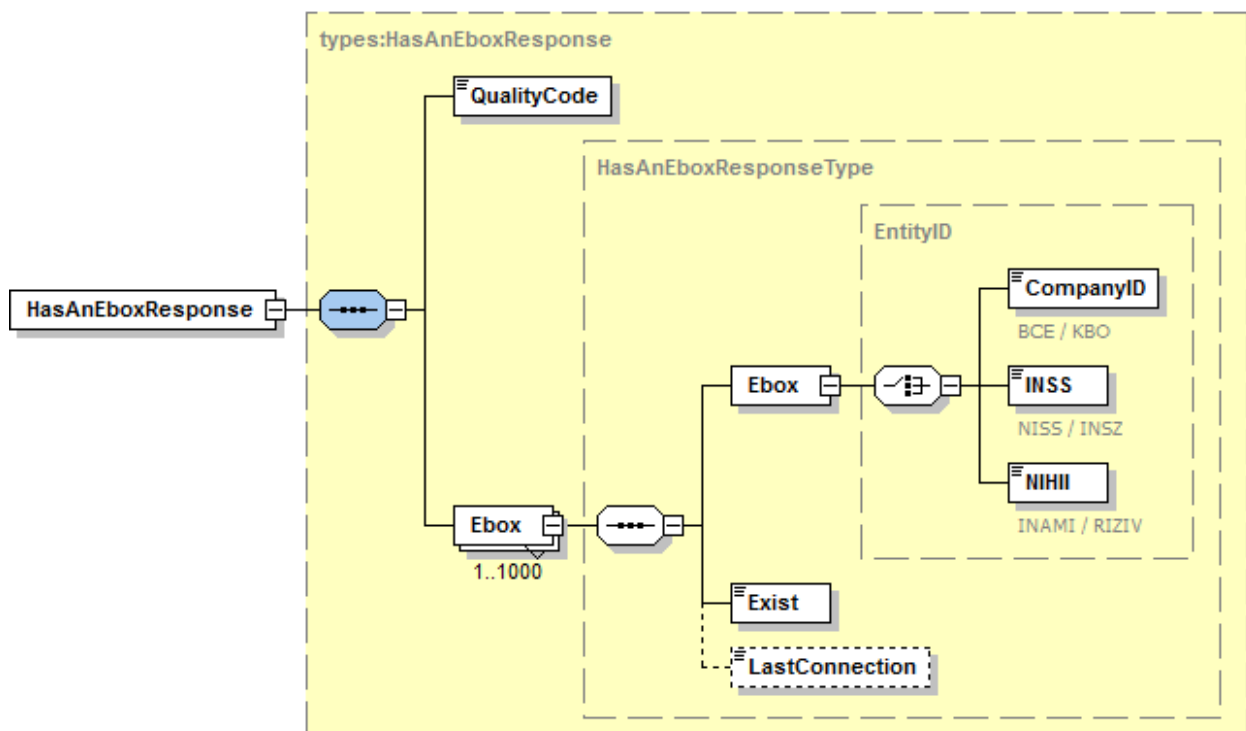

<sup>3</sup> Only for e-Box Enterprise (since new version of the webapplication in July 2014).

<sup>4</sup> Only for e-Box Enterprise (since new version of the webapplication in July 2014).

## 8 Description of the common types

This section presents the simple and complex types used to describe the message structure.

### 8.1 Simple types

#### 8.1.1 simpleType CBE

source	<pre>&lt;xs:simpleType name="CBE"&gt;   &lt;xs:annotation&gt;     &lt;xs:documentation&gt;BCE - KBO&lt;/xs:documentation&gt;   &lt;/xs:annotation&gt;   &lt;xs:restriction base="xs:string"&gt;     &lt;xs:pattern value="[0-9]{10}"&gt;   &lt;/xs:restriction&gt; &lt;/xs:simpleType&gt;</pre>
--------	---

#### 8.1.2 simpleType DigestMethod

source	<pre>&lt;xs:simpleType name="DigestMethod"&gt;   &lt;xs:annotation&gt;     &lt;xs:documentation&gt;Digest Algorithm ( SHA-1, SHA-256, SHA-512). &lt;/xs:documentation&gt;   &lt;/xs:annotation&gt;   &lt;xs:restriction base="xs:string"&gt;     &lt;xs:enumeration value="SHA-1"/&gt;     &lt;xs:enumeration value="SHA-256"/&gt;     &lt;xs:enumeration value="SHA-512"/&gt;   &lt;/xs:restriction&gt; &lt;/xs:simpleType&gt;</pre>
--------	---

#### 8.1.3 simpleType DigestValue

source	<pre>&lt;xs:simpleType name="DigestValue"&gt;   &lt;xs:annotation&gt;     &lt;xs:documentation&gt;Value of digest&lt;/xs:documentation&gt;   &lt;/xs:annotation&gt;   &lt;xs:restriction base="xs:base64Binary"&gt;     &lt;xs:minLength value="1"/&gt;     &lt;xs:maxLength value="150"/&gt;   &lt;/xs:restriction&gt; &lt;/xs:simpleType&gt;</pre>
--------	--

#### 8.1.4 simpleType Email

source	<pre>&lt;xs:simpleType name="Email"&gt;   &lt;xs:annotation&gt;</pre>
--------	---

	<pre> &lt;xs:documentation&gt;email adress&lt;/xs:documentation&gt; &lt;/xs:annotation&gt; &lt;xs:restriction base="xs:string"&gt;   &lt;xs:maxLength value="80"/&gt;   &lt;xs:pattern value="((([a-zA-Z0-9_]) ([a-zA-Z0-9_]) ([a-zA-Z0-9_ \-\.]*)([a-zA-Z0-9_])))(@)([a-zA-Z0-9\-\_]+)(\.[A-Za-z0-9]+)*(\.[a-zA-Z]{2,3})"/&gt; &lt;/xs:restriction&gt; &lt;/xs:simpleType&gt; </pre>
--	---

### 8.1.5 simpleType FileName

source	<pre> &lt;xs:simpleType name="FileName"&gt;   &lt;xs:annotation&gt;     &lt;xs:documentation&gt;Name to download the file.&lt;/xs:documentation&gt;   &lt;/xs:annotation&gt;   &lt;xs:restriction base="xs:string"&gt;     &lt;xs:minLength value="1"/&gt;     &lt;xs:maxLength value="80"/&gt;   &lt;/xs:restriction&gt; &lt;/xs:simpleType&gt; </pre>
--------	---

### 8.1.6 simpleType FreeText

source	<pre> &lt;xs:simpleType name="FreeText"&gt;   &lt;xs:annotation&gt;     &lt;xs:documentation&gt;Free text. Can be html or simple text. &lt;/xs:documentation&gt;   &lt;/xs:annotation&gt;   &lt;xs:restriction base="xs:string"&gt;     &lt;xs:minLength value="1"/&gt;     &lt;xs:maxLength value="5000"/&gt;   &lt;/xs:restriction&gt; &lt;/xs:simpleType&gt; </pre>
--------	--

### 8.1.7 simpleType INSS

source	<pre> &lt;xs:simpleType name="INSS"&gt;   &lt;xs:annotation&gt;     &lt;xs:documentation&gt;NISS - INSZ&lt;/xs:documentation&gt;   &lt;/xs:annotation&gt;   &lt;xs:restriction base="xs:string"&gt;     &lt;xs:pattern value="[0-9]{11}"/&gt;   &lt;/xs:restriction&gt; &lt;/xs:simpleType&gt; </pre>
--------	---

### 8.1.8 simpleType LeftCell

source	<pre> &lt;xs:simpleType name="LeftCell"&gt;   &lt;xs:annotation&gt;     &lt;xs:documentation&gt;Left cell of a table row &lt;/xs:documentation&gt;   &lt;/xs:annotation&gt; </pre>
--------	--

	<pre> &lt;/xs:annotation&gt; &lt;xs:restriction base="xs:string"&gt;   &lt;xs:minLength value="1"/&gt;   &lt;xs:maxLength value="50"/&gt; &lt;/xs:restriction&gt; &lt;/xs:simpleType&gt; </pre>
--	---

### 8.1.9 simpleType MessageType

source	<pre> &lt;xs:simpleType name="MessageType"&gt;   &lt;xs:annotation&gt;     &lt;xs:documentation xml:lang="en"&gt;Type of document.&lt;/xs:documentation&gt;   &lt;/xs:annotation&gt;   &lt;xs:restriction base="xs:string"&gt;     &lt;xs:minLength value="6"/&gt;     &lt;xs:maxLength value="80"/&gt;   &lt;/xs:restriction&gt; &lt;/xs:simpleType&gt; </pre>
--------	---

### 8.1.10 simpleType MIME

source	<pre> &lt;xs:simpleType name="MIME"&gt;   &lt;xs:annotation&gt;     &lt;xs:documentation xml:lang="en"&gt;MIME supported by e-Box. &lt;/xs:documentation&gt;   &lt;/xs:annotation&gt;   &lt;xs:restriction base="xs:string"&gt;     &lt;xs:enumeration value="application/pdf"/&gt;     &lt;xs:enumeration value="application/zip"/&gt;     &lt;xs:enumeration value="text/csv"/&gt;     &lt;xs:enumeration value="text/html"/&gt;     &lt;xs:enumeration value="text/plain"/&gt;     &lt;xs:enumeration value="text/xml"/&gt;     &lt;xs:enumeration value="application/vnd.oasis.opendocument.text"/&gt;     &lt;xs:enumeration value="application/vnd.oasis.opendocument.spreadsheet"/&gt;     &lt;xs:enumeration value="application/vnd.oasis.opendocument.presentation"/&gt;     &lt;xs:enumeration value="application/vnd.oasis.opendocument.graphics"/&gt;     &lt;xs:enumeration value="application/vnd.ms-excel"/&gt;     &lt;xs:enumeration value="application/vnd.openxmlformats-officedocument.spreadsheetml.sheet"/&gt;     &lt;xs:enumeration value="application/vnd.ms-powerpoint"/&gt;     &lt;xs:enumeration value="application/msword"/&gt;     &lt;xs:enumeration value="application/vnd.openxmlformats-officedocument.wordprocessingml.document"/&gt;   &lt;/xs:restriction&gt; &lt;/xs:simpleType&gt; </pre>
--------	---

### 8.1.11 simpleType Name

source	<pre> &lt;xs:simpleType name="Name"&gt;   &lt;xs:annotation&gt;     &lt;xs:documentation&gt;Name limited to 100 char&lt;/xs:documentation&gt;   &lt;/xs:annotation&gt; </pre>
--------	---

	<pre> &lt;xs:restriction base="xs:string"&gt;   &lt;xs:minLength value="1"/&gt;   &lt;xs:maxLength value="100"/&gt; &lt;/xs:restriction&gt; &lt;/xs:simpleType&gt; </pre>
--	---

### 8.1.12 simpleType NIHII

source	<pre> &lt;xs:simpleType name="NIHII"&gt;   &lt;xs:annotation&gt;     &lt;xs:documentation&gt;INAMI - RIZIV&lt;/xs:documentation&gt;   &lt;/xs:annotation&gt;   &lt;xs:restriction base="xs:string"&gt;     &lt;xs:pattern value="[0-9]{8}"/&gt;   &lt;/xs:restriction&gt; &lt;/xs:simpleType&gt; </pre>
--------	---

### 8.1.13 simpleType QualityCode

source	<pre> &lt;xs:simpleType name="QualityCode"&gt;   &lt;xs:annotation&gt;     &lt;xs:documentation&gt;Quality code from the userManagement of social security. Ex :     QUAL_EMP_NOSS, QUAL_SSC, QUAL_SP_IND, ...&lt;/xs:documentation&gt;   &lt;/xs:annotation&gt;   &lt;xs:restriction base="xs:string"&gt;     &lt;xs:minLength value="1"/&gt;     &lt;xs:maxLength value="125"/&gt;   &lt;/xs:restriction&gt; &lt;/xs:simpleType&gt; </pre>
--------	--

### 8.1.14 simpleType RightCell

source	<pre> &lt;xs:simpleType name="RightCell"&gt;   &lt;xs:annotation&gt;     &lt;xs:documentation&gt;Righ cell of a table row &lt;/xs:documentation&gt;   &lt;/xs:annotation&gt;   &lt;xs:restriction base="xs:string"&gt;     &lt;xs:minLength value="1"/&gt;     &lt;xs:maxLength value="150"/&gt;   &lt;/xs:restriction&gt; &lt;/xs:simpleType&gt; </pre>
--------	--

### 8.1.15 simpleType Sequence

source	<pre> &lt;xs:simpleType name="Sequence"&gt;   &lt;xs:annotation&gt;     &lt;xs:documentation&gt;Additional Number to publish many different document with the same     Ticket. &lt;/xs:documentation&gt;   &lt;/xs:annotation&gt; </pre>
--------	--

	<pre> &lt;xs:restriction base="xs:integer"&gt;   &lt;xs:minInclusive value="0"/&gt;   &lt;xs:maxInclusive value="99999"/&gt; &lt;/xs:restriction&gt; &lt;/xs:simpleType&gt; </pre>
--	--

### 8.1.16 simpleType ShortString

source	<pre> &lt;xs:simpleType name="ShortString"&gt;   &lt;xs:annotation&gt;     &lt;xs:documentation&gt;Short string limited to 25 char&lt;/xs:documentation&gt;   &lt;/xs:annotation&gt;   &lt;xs:restriction base="xs:string"&gt;     &lt;xs:minLength value="1"/&gt;     &lt;xs:maxLength value="25"/&gt;   &lt;/xs:restriction&gt; &lt;/xs:simpleType&gt; </pre>
--------	---

### 8.1.17 simpleType ShortTitle

source	<pre> &lt;xs:simpleType name="ShortTitle"&gt;   &lt;xs:annotation&gt;     &lt;xs:documentation&gt;Title of table. Limited to 25 char&lt;/xs:documentation&gt;   &lt;/xs:annotation&gt;   &lt;xs:restriction base="xs:string"&gt;     &lt;xs:minLength value="1"/&gt;     &lt;xs:maxLength value="50"/&gt;   &lt;/xs:restriction&gt; &lt;/xs:simpleType&gt; </pre>
--------	---

### 8.1.18 simpleType Ticket

source	<pre> &lt;xs:simpleType name="Ticket"&gt;   &lt;xs:annotation&gt;     &lt;xs:documentation&gt;Functionnal ID of the document.&lt;/xs:documentation&gt;   &lt;/xs:annotation&gt;   &lt;xs:restriction base="xs:string"&gt;     &lt;xs:minLength value="1"/&gt;     &lt;xs:maxLength value="25"/&gt;   &lt;/xs:restriction&gt; &lt;/xs:simpleType&gt; </pre>
--------	--

### 8.1.19 simpleType Title

source	<pre> &lt;xs:simpleType name="Title"&gt;   &lt;xs:annotation&gt;     &lt;xs:documentation&gt;Same as subject of mail&lt;/xs:documentation&gt;   &lt;/xs:annotation&gt;   &lt;xs:restriction base="xs:string"&gt;     &lt;xs:minLength value="1"/&gt;   &lt;/xs:restriction&gt; &lt;/xs:simpleType&gt; </pre>
--------	--

	<pre>&lt;xs:maxLength value="400"/&gt; &lt;/xs:restriction&gt; &lt;/xs:simpleType&gt;</pre>
--	---

## 8.2 complexType: *MessageID*

**Ticket:** functional identifier of the message. Most often, the ticket has a business meaning for the application that sends the message (for example, the reference of a declaration).

**Sequence [optional]:** The sequence number is used to publish different versions of a message having the same ticket number. For example, it is possible to have 3 messages with ticket “12345678”, and sequence “1”; “2” and “3” for each version of the message.

Sending a message with an already used ticket/sequence combo will replace the existing message.

diagram	
source	<pre>&lt;xs:complexType name="MessageID"&gt;   &lt;xs:annotation&gt;     &lt;xs:documentation&gt;ID of the message.&lt;/xs:documentation&gt;   &lt;/xs:annotation&gt;   &lt;xs:sequence&gt;     &lt;xs:element name="Ticket" type="Ticket"/&gt;     &lt;xs:element name="Sequence" type="Sequence" minOccurs="0"/&gt;   &lt;/xs:sequence&gt; &lt;/xs:complexType&gt;</pre>

**For the e-Box user:** ticket / sequence are only displayed in “e-Box Enterprise” and “e-Box Professional”:

- For an e-Box user, the ticket / sequence are displayed on the “details page” of each message. Ticket can be used as search criteria in e-Box Enterprise and e-Box Professional. (Ticket is not displayed in eBox Citizen).
- For the sender and for e-Box Team, the ticket can be used to search the message in the e-Box system (for example, in order to check the message publication). The ticket is also used to inform the sender of the message status [read / unread].



## 8.3 complexType: RecipientID

<p>diagram</p>	<p>Identify the recipient of the message. The recipient can be an entreprise, an institution, a professional of social security.</p> <p>Identify the person who ask the document</p>
<p>source</p>	<pre> &lt;xs:complexType name="RecipientID"&gt;   &lt;xs:annotation&gt;     &lt;xs:documentation&gt;Identify the recipient of the message. The recipient can be an     entreprise, an institution, a professional of social security or a citizen.&lt;/xs:documentation&gt;   &lt;/xs:annotation&gt;   &lt;xs:sequence&gt;     &lt;xs:choice&gt;       &lt;xs:element name="CompanyID" type="CBE"&gt;         &lt;xs:annotation&gt;           &lt;xs:documentation&gt;BCE / KBO&lt;/xs:documentation&gt;         &lt;/xs:annotation&gt;       &lt;/xs:element&gt;       &lt;xs:element name="INSS" type="INSS"&gt;         &lt;xs:annotation&gt;           &lt;xs:documentation&gt;NISS / INSZ&lt;/xs:documentation&gt;         &lt;/xs:annotation&gt;       &lt;/xs:element&gt;       &lt;xs:element name="NIHII" type="NIHII"&gt;         &lt;xs:annotation&gt;           &lt;xs:documentation&gt;INAMI / RIZIV &lt;/xs:documentation&gt;         &lt;/xs:annotation&gt;       &lt;/xs:element&gt;     &lt;/xs:choice&gt;     &lt;xs:element name="QualityCode" type="QualityCode"/&gt;     &lt;xs:element name="Person" type="Person" minOccurs="0"&gt;       &lt;xs:annotation&gt;         &lt;xs:documentation&gt;Identify the person who ask the document&lt;/xs:documentation&gt;       &lt;/xs:annotation&gt;     &lt;/xs:element&gt;   &lt;/xs:sequence&gt; &lt;/xs:complexType&gt; </pre>

A RecipientID defines an “Entity/Quality” couple that identifies the e-Box where the message will be published.

**CompanyID** or **INSS** or **NIHII**: entity id of the recipient, according to the entity type, respectively, an organization (enterprise or institution), an individual (for example a Citizen) or a provider of health care.

- An organization (enterprise or institution) is identified with a **CompanyID** (*numéro BCE/KBO nummer*);
- A natural person (Citizen / Professional / Curator ; “Service Provider *Natural Person*”....) is identified with its **INSS** (NISS / INSZ);

- A healthcare provider could be identified by its **NIHII** (n° INAMI / RIZIV).

**QualityCode:** quality code linked to the given entity. The quality code depends of the “Box type”

→ See annex [10.2](#) for a non-exhaustive list of quality codes.

**Person:** cf. [complexType: Person](#)

## 8.4 complexType: *Person*

**Person** [*optional; only for “e-Box Enterprise” and “e-Box Professional Institution”.*]: a person who is a target recipient among the different users of the specified e-Box.

A person is identified by its *INSS*, *FirstName* and *LastName*.

*NB:* The system does not check if the person is an effective user of the given e-Box.

diagram	<p>The diagram shows a class named 'Person' with the documentation 'Identify a person in an e-Box.' This class is connected to three other classes: 'INSS' (with documentation 'INSZ / NISS'), 'FirstName', and 'LastName'.</p>
source	<pre> &lt;xs:complexType name="Person"&gt;   &lt;xs:annotation&gt;     &lt;xs:documentation&gt;Identify a person in an e-Box. &lt;/xs:documentation&gt;   &lt;/xs:annotation&gt;   &lt;xs:sequence&gt;     &lt;xs:element name="INSS" type="INSS"&gt;       &lt;xs:annotation&gt;         &lt;xs:documentation&gt;INSZ / NISS&lt;/xs:documentation&gt;       &lt;/xs:annotation&gt;     &lt;/xs:element&gt;     &lt;xs:element name="FirstName" type="Name"/&gt;     &lt;xs:element name="LastName" type="Name"/&gt;   &lt;/xs:sequence&gt; &lt;/xs:complexType&gt; </pre>

## 8.5 complexType: *File*

**This complex type is used for a Document or an Annex.**

**Title:** Title of the sent document. It looks like an “email subject” in e-Box (cf. print-screen just below).

**Content:** URI that references the document in attachment (using swaRef standard).

**Digest [optional]:** In order to check the integrity of the message content, the sender can add the hash of the document (DigestValue). The WS will then verify that the provided digest is the same as the document digest computed according to the provided method (SHA-1; SHA-256 or SHA-512).

**DownloadFileName:** name used to open or save the document (cf. print-screen just below).

**MIME [optional]:** MIME type of the document (cf. [8.1. Simple Types](#) for the different possibilities). In e-Box, this information is available on the “details page” of a message (cf. print-screen just below).

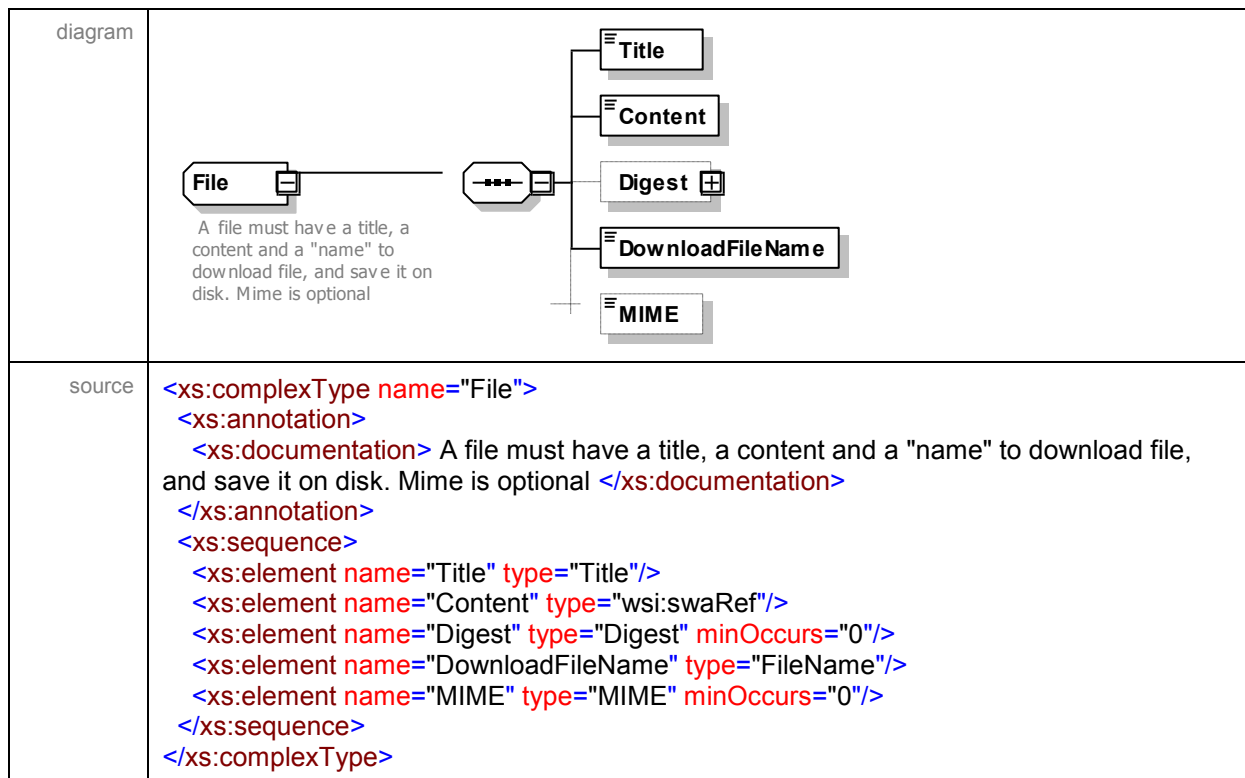

Emetteur	Description	Type	Date d'envoi
	Document SIGEDIS pour démo <a href="#">Ouvrir</a> <a href="#">Télécharger</a> <a href="#">Archiver</a>		03 mai 2013
	Test pour ONEM: Décision C62 <a href="#">Ouvrir</a> <a href="#">Télécharger</a>		19 avril 2013

Figure 6 - "Title" of a message (eBox Citizen)

Figure 7 - "DownloadFileName" (eBox Citizen) [browser Mozilla Firefox]

## 8.6 complexType: *Digest*

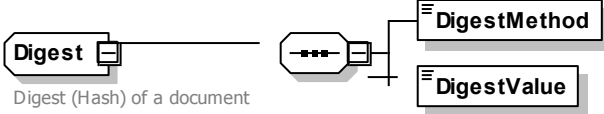
diagram	 <p>Digest (Hash) of a document</p>
source	<pre>&lt;xs:complexType name="Digest"&gt;   &lt;xs:annotation&gt;     &lt;xs:documentation&gt;Digest (Hash) of a document&lt;/xs:documentation&gt;   &lt;/xs:annotation&gt;   &lt;xs:sequence&gt;     &lt;xs:element name="DigestMethod" type="DigestMethod"/&gt;     &lt;xs:element name="DigestValue" type="DigestValue"/&gt;   &lt;/xs:sequence&gt; &lt;/xs:complexType&gt;</pre>

## 8.7 complexType: *FreeInformation*

Free information could be added for each published message in e-Box Enterprise or e-Box Professional (not used in eBox Citizen).

Free information is a free text or a table.

On the “details page” of the message, the table or the free text is displayed on the top right side of the

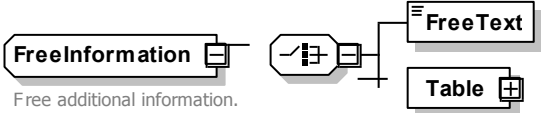
diagram	 <p>Free additional information.</p>
source	<pre>&lt;xs:complexType name="FreeInformation"&gt;   &lt;xs:annotation&gt;     &lt;xs:documentation&gt;Free additional information.&lt;/xs:documentation&gt;   &lt;/xs:annotation&gt;   &lt;xs:choice&gt;     &lt;xs:element name="FreeText" type="FreeText"/&gt;     &lt;xs:element name="Table" type="Table"/&gt;   &lt;/xs:choice&gt; &lt;/xs:complexType&gt;</pre>

page (cf. print-screens just below).

Détail du document nouveau test avec free text [Retour](#)

**Description**

N° de ticket	1298346795
N° de séquence	0
Date d'expiration	27-03-2012
Type de message	DocWIDE
Numéro d'immatriculation ONSS	5110468182
Numéro d'immatriculation ONSS	5110468182
Numéro d'immatriculation ONSS	1234567890

Attention, document confidentiel. Veuillez ne pas divulguer les informations reprises dans le document PDF.

FreeInformation:FreeText

**Document principal**

Description	Format	Type de signature
<a href="#">nouveau test avec free text</a>		

**Annexes**

Pas d'annexes pour ce message

Figure 8 - "FreeInformation»: free text (e-Box Professional)

## 8.8 complexType Table

diagram	<p>Table like html table to display some free value. This table has only 2 column and max 10 row.</p>
source	<pre> &lt;xs:complexType name="Table"&gt;   &lt;xs:annotation&gt;     &lt;xs:documentation&gt;Table like html table to display some free value. This table has only 2 column and max 10 row.&lt;/xs:documentation&gt;   &lt;/xs:annotation&gt;   &lt;xs:sequence&gt;     &lt;xs:element name="Title" type="ShortTitle"/&gt;     &lt;xs:element name="Row" type="Row" maxOccurs="10"/&gt;   &lt;/xs:sequence&gt; &lt;/xs:complexType&gt; </pre>

Détail du document Envoi formulaire X-Y.Z pour démo (avec annexe) [Retour](#)

## FreeInformation: Table

**Description**

N° de ticket	TST_WS_2013-05-30_b04
N° de séquence	1
Date d'expiration	30-08-2013
Type de message	Document e-Box

**Tableau informatif concernant le formulaire X-Y.Z**

Date demande	26-05-2013
Votre correspondant	Mr. X. XXXXXXXXXXX
Numero de dossier	123-XXXXXXXXXX-XYZ
Date limite de retour	30-06-2013

**Document principal**

Description	Format	Type de signature
<a href="#">Envoi formulaire X-Y.Z pour démo (avec annexe)</a>	application/pdf	

**Annexes**

Description	Format	Type de signature
<a href="#">Document Annexe 1 - version .doc du formulaire</a>	application/msword	

Figure 9 - "FreeInformation": table (e-Box Professional)

## 8.9 complexType Row

diagram	<p style="font-size: small;">Row of a table.</p>
source	<pre>&lt;xs:complexType name="Row"&gt;   &lt;xs:annotation&gt;     &lt;xs:documentation&gt;Row of a table.&lt;/xs:documentation&gt;   &lt;/xs:annotation&gt;   &lt;xs:sequence&gt;     &lt;xs:element name="LeftCell" type="LeftCell"/&gt;     &lt;xs:element name="RightCell" type="RightCell"/&gt;   &lt;/xs:sequence&gt; &lt;/xs:complexType&gt;</pre>

### 8.10 complexType: Meta

Metadata are defined with the message type (by means of the e-Box form, cf. [How to publish for the first time to e-Box?](#))

Metadata are used to add more structured information about the message. A metadata can be optional or mandatory.

A type is defined for each metadata and the value must match with its type (for example: BENOSS number, date, etc.).

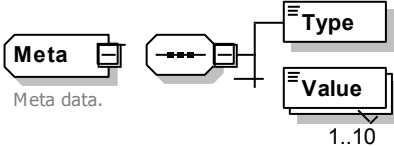
diagram	 <p>Meta data.</p> <p>1..10</p>
source	<pre>&lt;xs:complexType name="Meta"&gt;   &lt;xs:annotation&gt;     &lt;xs:documentation&gt;Meta data. &lt;/xs:documentation&gt;   &lt;/xs:annotation&gt;   &lt;xs:sequence&gt;     &lt;xs:element name="Type" type="ShortString"/&gt;     &lt;xs:element name="Value" type="ShortString" maxOccurs="10"/&gt;   &lt;/xs:sequence&gt; &lt;/xs:complexType&gt;</pre>

### Meta for an e-Box User:

In e-Box, metadata are displayed on the “details page” of a message, into the “Description” section. Metadata can be used as search criteria among messages of a same type.

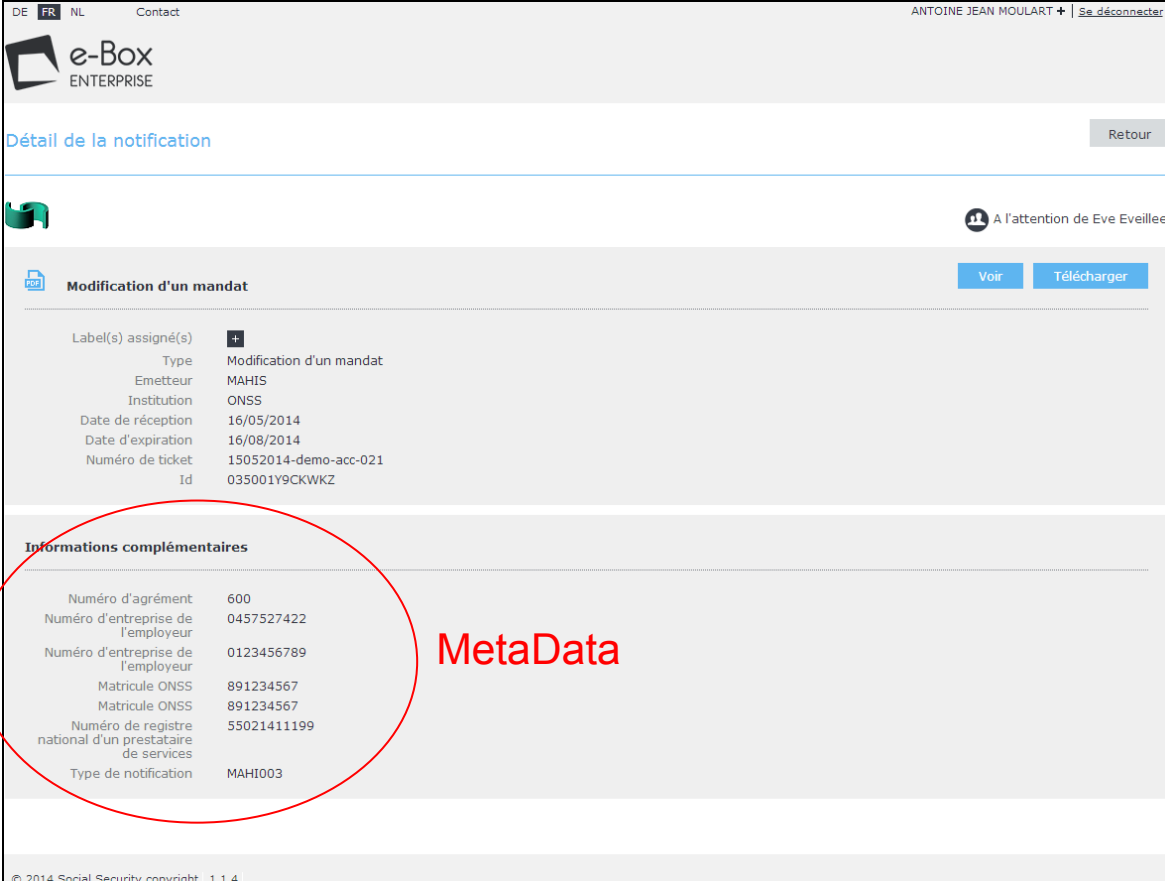

DE FR NL Contact ANTOINE JEAN MOULART + | Se déconnecter

e-Box ENTERPRISE

Détail de la notification Retour

A l'attention de Eve Eveillee

**Modification d'un mandat** Voir Télécharger

Label(s) assigné(s) +

Type	Modification d'un mandat
Emetteur	MAHIS
Institution	ONSS
Date de réception	16/05/2014
Date d'expiration	16/08/2014
Numéro de ticket	15052014-demo-acc-021
Id	035001Y9CKWKZ

**Informations complémentaires**

Numéro d'agrément	600
Numéro d'entreprise de l'employeur	0457527422
Numéro d'entreprise de l'employeur	0123456789
Matricule ONSS	891234567
Matricule ONSS	891234567
Numéro de registre national d'un prestataire de services	55021411199
Type de notification	MAHI003

© 2014 Social Security copyright 1.1.4

Figure 10 - "Metadata" displayed on the "message details" page (e-Box Enterprise)

Figure 11 - "Metadata" used as search criteria (e-Box Enterprise)

## 8.11 complexType EntityID

(cf. [complexType: RecipientID](#))

<p>diagram</p> <p>Identify the recipient of the message. The recipient can be an entreprise, an institution, or a professional of social security.</p>	<pre> classDiagram     class EntityID     class CompanyID {         BCE / KBO     }     class INSS {         NISS / INSZ     }     class NIHI {         INAMI / RIZIV     }     EntityID -- &gt; CompanyID     EntityID -- &gt; INSS     EntityID -- &gt; NIHI     </pre>
<p>source</p>	<pre> &lt;xs:complexType name="EntityID"&gt;   &lt;xs:annotation&gt;     &lt;xs:documentation xml:lang="en"&gt;Identify the recipient of the message. The recipient     can be an entreprise, an institution, or a professional of social security.   &lt;/xs:documentation&gt;   &lt;/xs:annotation&gt;   &lt;xs:sequence&gt;     &lt;xs:choice&gt;       &lt;xs:element name="CompanyID" type="CBE"&gt;         &lt;xs:annotation&gt; </pre>



	<pre>&lt;xs:documentation xml:lang="en"&gt;BCE / KBO&lt;/xs:documentation&gt; &lt;/xs:annotation&gt; &lt;/xs:element&gt; &lt;xs:element name="INSS" type="INSS"&gt;   &lt;xs:annotation&gt;     &lt;xs:documentation xml:lang="en"&gt;NISS / INSZ&lt;/xs:documentation&gt;   &lt;/xs:annotation&gt; &lt;/xs:element&gt; &lt;xs:element name="NIHII" type="NIHII"&gt;   &lt;xs:annotation&gt;     &lt;xs:documentation xml:lang="en"&gt;INAMI / RIZIV &lt;/xs:documentation&gt;   &lt;/xs:annotation&gt; &lt;/xs:element&gt; &lt;/xs:choice&gt; &lt;/xs:sequence&gt; &lt;/xs:complexType&gt;</pre>
--	---

## 9 Common error codes

### System Error Codes:

These error codes indicate a problem in the request sent or a system error.

Code	Description	Cause	Explication
SOA-00001	Service error		This is the default error sent to the consumer in case no more details are known.
SOA-01001	Service call not authenticated	Consumer	From the security information provided, either the consumer could not be identified or the credentials provided are not correct.
SOA-01002	Service call not authorized	Consumer	The consumer is identified and authenticated, but is not allowed to call the given service.
SOA-02001	Service not available. Please contact service desk.	Provider	An unexpected error has occurred. Retries will not work. Service desk may help with root cause analysis.
SOA-02002	Service temporarily not available. Please try later.	Provider	An unexpected error has occurred. Retries should work. If the problem persists service desk may help.
SOA-03001	Malformed message	Consumer	This is the default error for content related errors in case no more details are known.
SOA-03002	Message must be SOAP	Consumer	Message does not respect the SOAP standard.
SOA-03003	Message must contain SOAP body	Consumer	Message respects the SOAP standard, but body is missing.
SOA-03004	WS-I compliance failure	Consumer	Message does not respect the WS-I standard.
SOA-03005	WSDL compliance failure	Consumer	Message is not compliant with WSDL.
SOA-03006	XSD compliance failure	Consumer	Message is not compliant with XSD.
SOA-03007	Message content validation failure	Consumer	From the message content (conform XSD): extended checks on the element format failed or cross-checks between fields failed.

### Business Error Codes (for operation publishEboxMessage):

These error codes are defined by the application.

Code	Explication
10	Hash computed not equal to the providing hash
20	The provided institution ID is not authorized to publish for another institution
30	You are authenticated as MandateSender. A MandateSender must specify a SenderID in SOAP request.
40	The combo institution/application can not send this message type
50	A given meta data is not authorized for this kind of message
51	A given meta data is not well formed according the regular expression
52	A required meta is missing according to the constraints
90	Invalid Recipient

## 10 Annex

### 10.1 WS EBoxMessage EndPoint URI:

Integration:	<a href="https://professionalservices-int.socialsecurity.be/EBoxMessage/v1">https://professionalservices-int.socialsecurity.be/EBoxMessage/v1</a>
Acceptation:	<a href="https://professionalservices-acpt.socialsecurity.be/EBoxMessage/v1">https://professionalservices-acpt.socialsecurity.be/EBoxMessage/v1</a>
Production:	<a href="https://professionalservices.socialsecurity.be/EBoxMessage/v1">https://professionalservices.socialsecurity.be/EBoxMessage/v1</a>

### 10.2 Common Quality Codes:

Non-exhaustive list of quality codes:

e-Box Type	Quality Code	FR	NL	Expected entity ID type
e-Box Enterprise	QUAL_EMP_NOSS	Employeur ONSS	Werkgever RSZ	CompanyID
	QUAL_EMP_NOSSPLA	Employeur ONSS-APL	Werkgever RSZ-PPO	CompanyID
	QUAL_COMPANY	Entreprise sans personnel	Onderneming zonder personeel	CompanyID
	QUAL_SSC	Secrétariat sociale agréé	Erkend sociaal secretariaat	CompanyID
	QUAL_SP_LEG	Prestataire de services (personne morale)	Dienstverlener (rechtspersoon)	CompanyID
	QUAL_SP_IND	Prestataire de services (personne physique)	Dienstverlener (natuurlijke persoon)	INSS
	QUAL_FSC	Full Service Center APL	Full Service Center PPO	CompanyID
	QUAL_SPPLA_LEG	Prestataire de services ONSSAPL	Dienstverlener ONSSAPL	CompanyID
	QUAL_CUR	Curateur	Curator	INSS
e-Box Professionnal (Institution)	QUAL_MUN_ADM	Administration Communale	Gemeente bestuur	CompanyID
	QUAL_MUT_SOCSEC	Mutuelle en matière de sécurité sociale	Mutualiteit voor de sociale zekerheid	CompanyID
	QUAL_SOC_ACTION	Action Sociale	Maatschappelijk Welzijn	CompanyID
	QUAL_COMP_PENSION	Gestionnaire pensions complémentaires	Beheerder aanvullende pensioenen	CompanyID
e-Box Professional (Personnal)	PROFESSIONAL	<i>Professionnel (fonctionnaire)</i>	<i>professioneel (ambtenaar)</i>	INSS
eBox Citizen	CITIZEN	<i>Citoyen</i>	Burger	INSS

If you need to publish to an e-Box with another quality type, you can ask to [eBoxIntegration@smals.be](mailto:eBoxIntegration@smals.be) to get the valid quality code to use.

## 10.3 Using the X.509 certificate

Each request to the WS EBoxMessage must be signed with a X.509 certificate (cf.5.2.).

### 10.3.1 Dedicated certificate by sending application

For this use, each application of a same institution has a dedicated certificate. The sender doesn't have to give a "Sender tag" in the request.

CompanyID of the institution and URN of the application are automatically detected in the request signature made by means of the X.509 certificate.

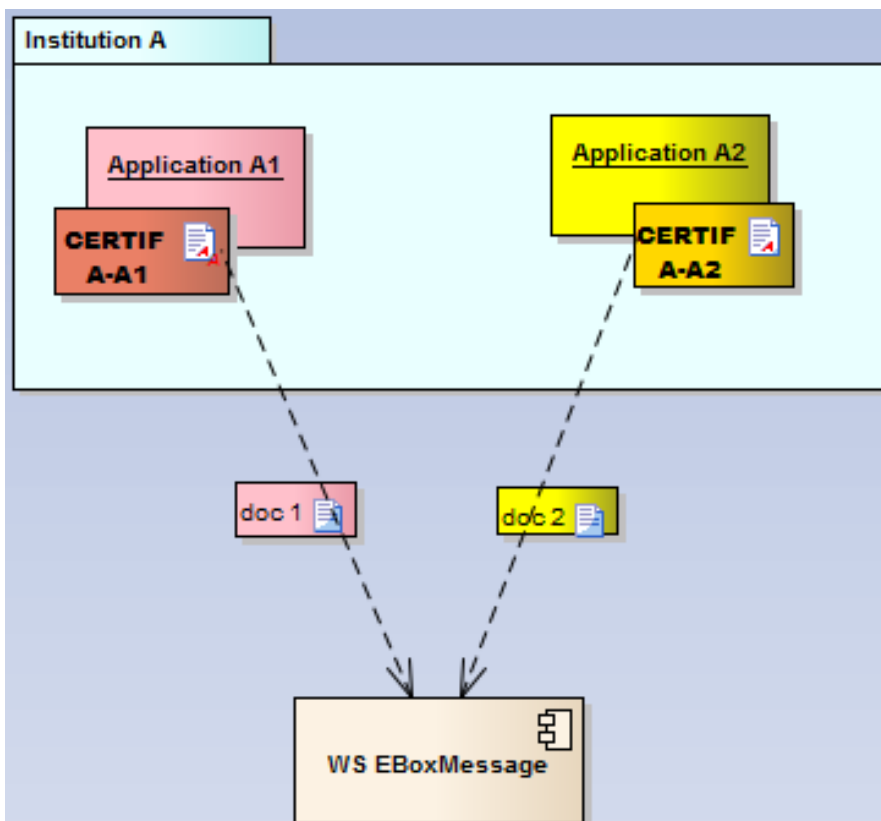
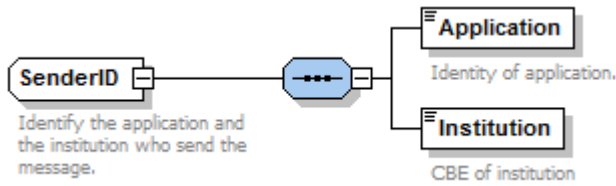

Figure 12 - Dedicated certificate by application

### 10.3.2 Single certificate shared by several sending applications

For this use, each application of a same institution uses the same certificate. The sender has to give a "Sender tag" in the request, in order to indicate for which application the message will be published.



```

<SenderID>
  <Application>${urn:of:application-to-indicate}</Application>
  <Institution>${0123456789}</Institution>
</SenderID>

```

The value given in the "SenderID→Institution" tag must be the CompanyID of the institution, which is also detected and checked in the request signature made by means of the X.509 certificate.

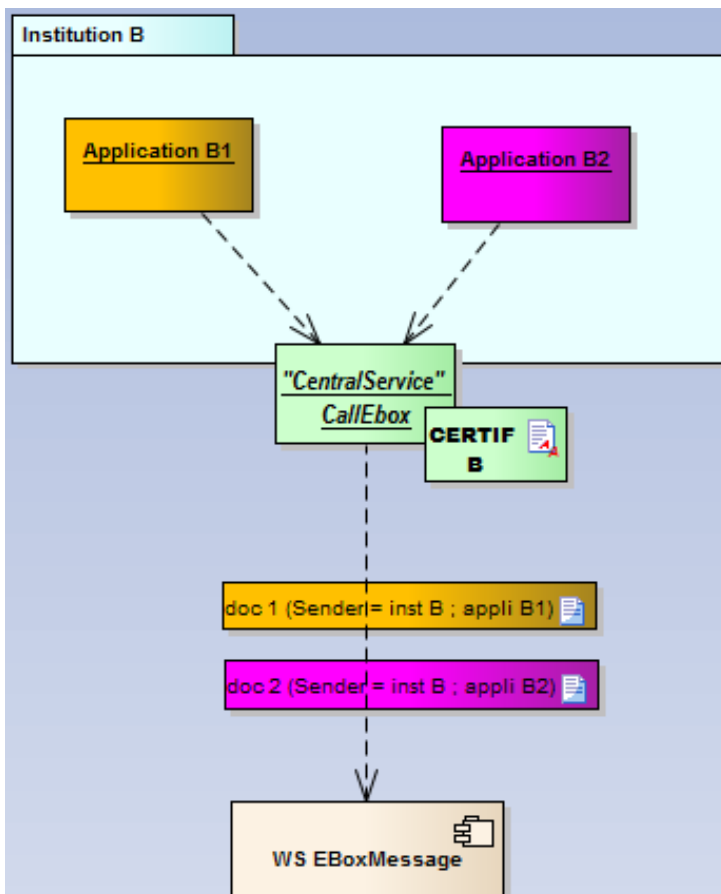

Figure 13 - Single certificate shared by several applications

## 11 Summary: How to publish for the first time to e-Box?

Here are the steps an institution must follow to publish for the first time to e-Box.

- 1) Gather information about e-Box, contact the e-Box Team and organize a meeting if necessary
- 2) Complete the e-Box form (available on <http://portalinfo.smals.be/> )
- 3) Asking for validation of the e-Box form (via [eBoxIntegration@smals.be](mailto:eBoxIntegration@smals.be) )
- 4) After form validation, integrate the WS, order the x.509 certificate
- 5) Testing (Integration, Acceptance)
- 6) Publish to e-Box (Production)

## 12 Contact points

<b>e-Box team:</b>	<a href="mailto:eBoxIntegration@smals.be">eBoxIntegration@smals.be</a>
CSM Smals:	Catherine Schoetter
CPL Smals:	Roel Biermans
PL Smals (TO&P):	Jérôme Vos
PL Smals (GA/TB):	Barbara Meyers
SPOC Smals "eBox Citizen":	Kristien Plomteux
e-Box analyst (Smals):	Antoine Moulart
e-Box architect (Smals):	Adrien Clerbaut
SPOC <b>NSSO</b> (e-Box Enterprise):	Philippe Benoît (ONSS-RSZ)
SPOC <b>CBSS</b> (e-Box Professional & eBox Citizen):	Claudia Laeremans (BCSS-KSZ)